

Data sheet



ROOF DRAIN FOR GRAVITY
 - Roof: bitumen
 - Flange: 400x400mm
 - Outlet: Ø75mm, vertical
 - Stainless steel: AISI304/EN1.4301

DATA

Type no.: 401.104.075
 EAN no.: 5705499132748
 VVS no.: 164100075
 RSK no.: 5173692
 NRF no.:
 LVI no.: 3384519

Type: Standard
 Roof: Bitumen
 System: Gravity
 Outlet direction: Vertical
 Outlet dia. (mm): 75
 Weight (kg): 1,96
 Material: AISI 304
 Material: EN 1.4301

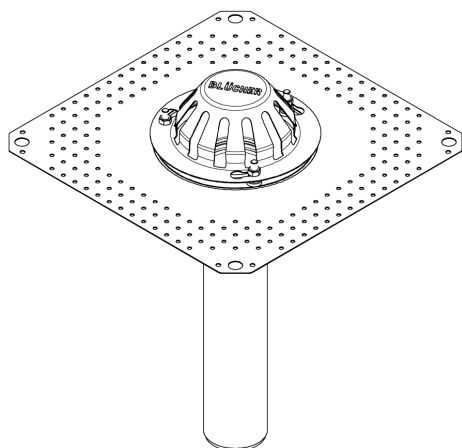
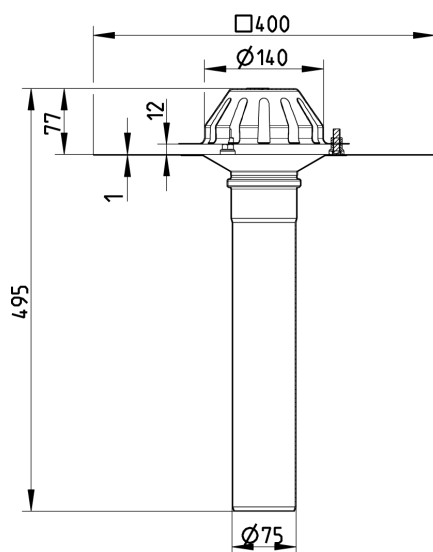

Approvals

DE - LGA Certificate 57214035 d
 DK - VA 2.99/19975-17
 NO - PS1893-ROOF-18
 PL - Hygienic Certificate - All products